

My book about

6

6 hearts

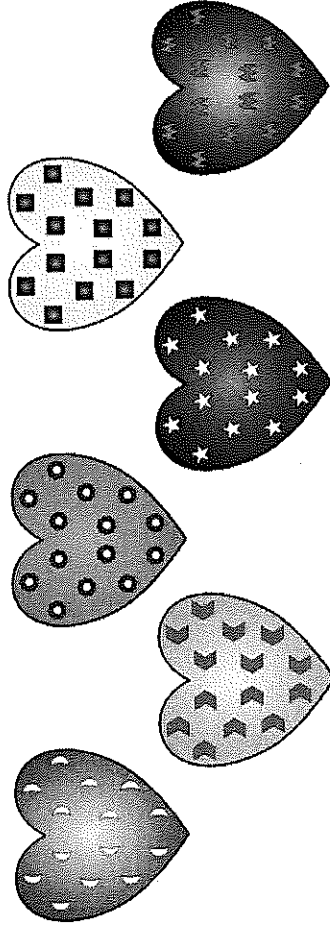

This book belongs to

\_\_\_\_\_

Can you see 6?

Find all the number 6s and circle them.

9

8

5

3

6

6

6

0

1

6

8

3

6

5

Write how many in the circles.

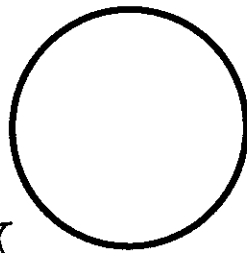
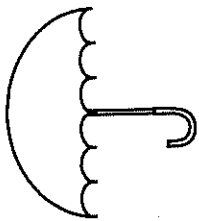
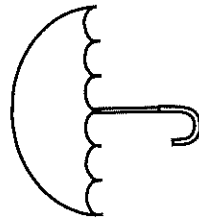
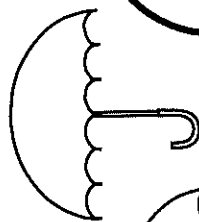
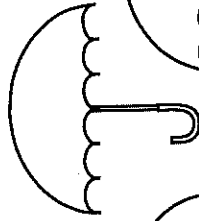
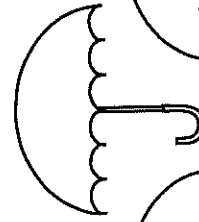
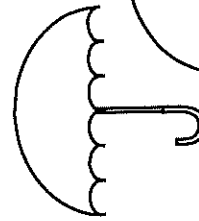
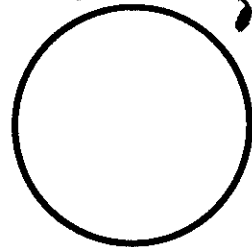
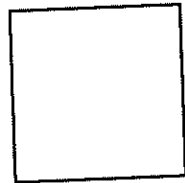
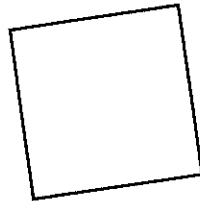
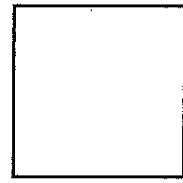
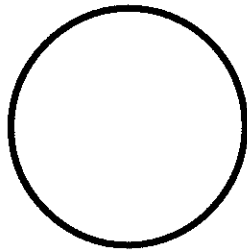
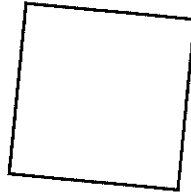
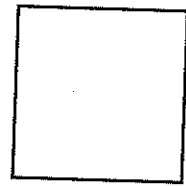
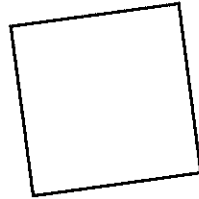

Shout out **6**!

Slowly trace your hand along the line. When you reach a number 6, shout it out!

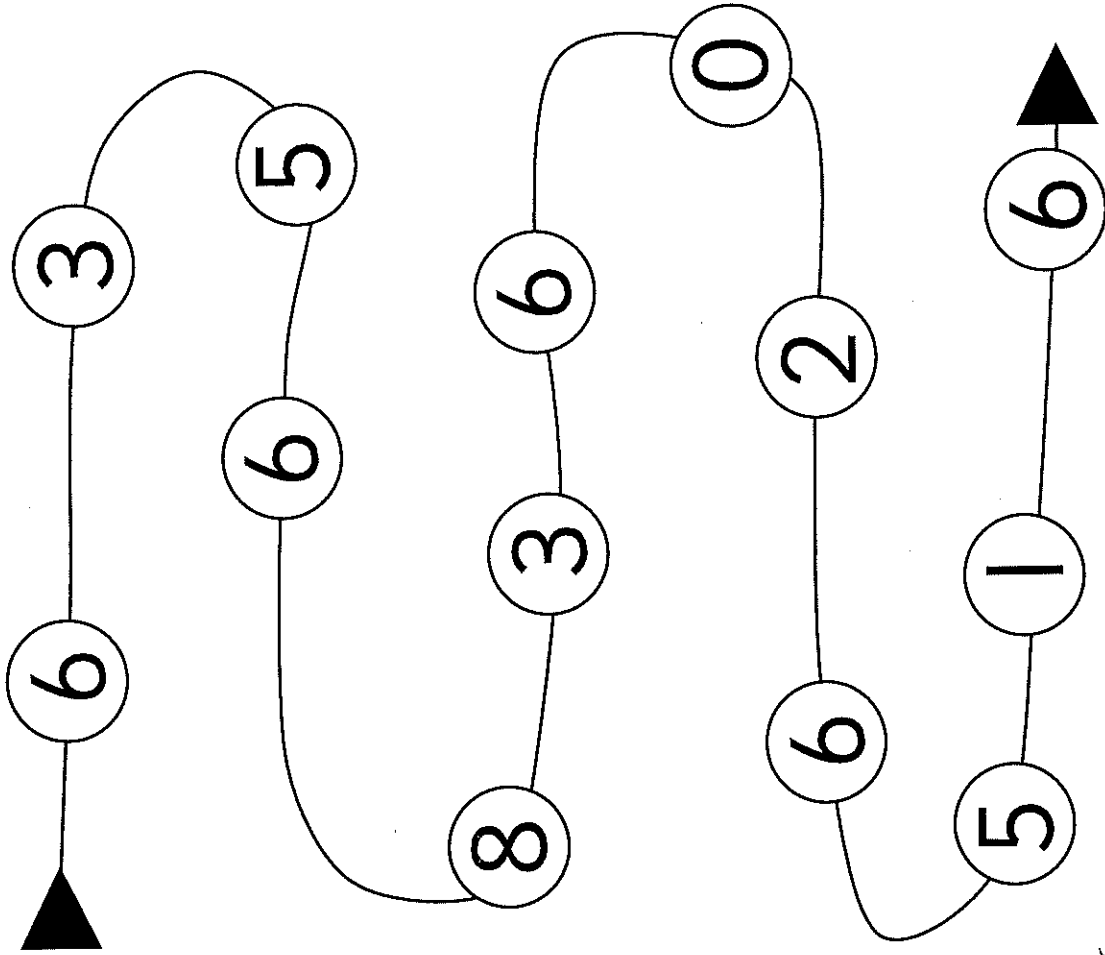

Choose 6 rainbow colours and trace within the giant 6 below.

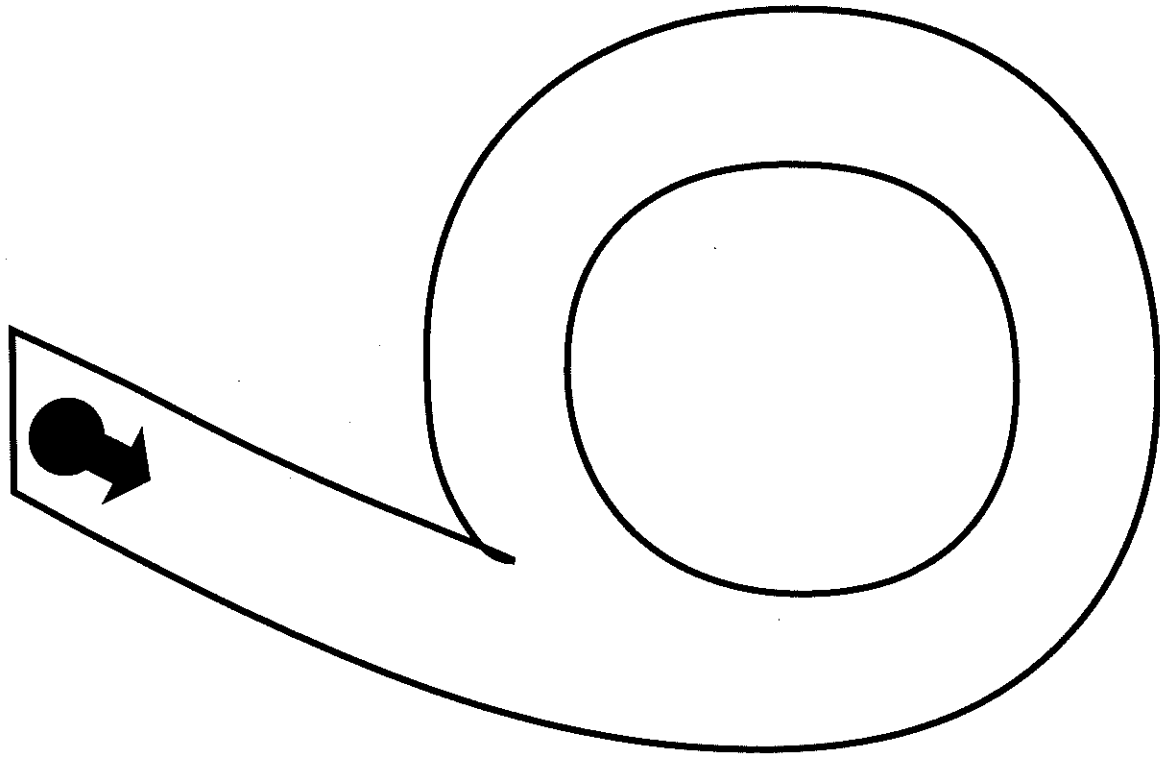

Colour the number 6 rabbit.

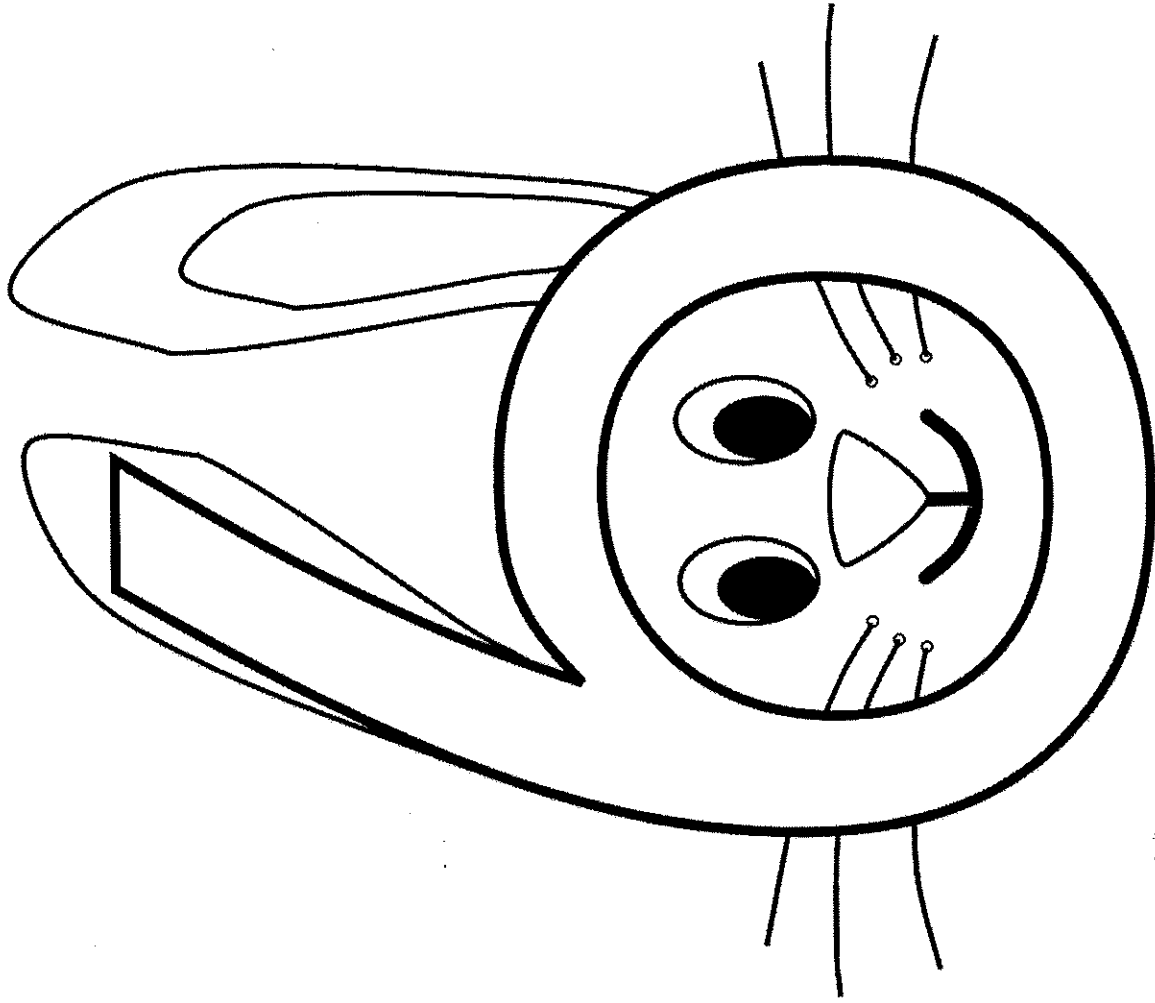

Draw 6 stars around the moon.

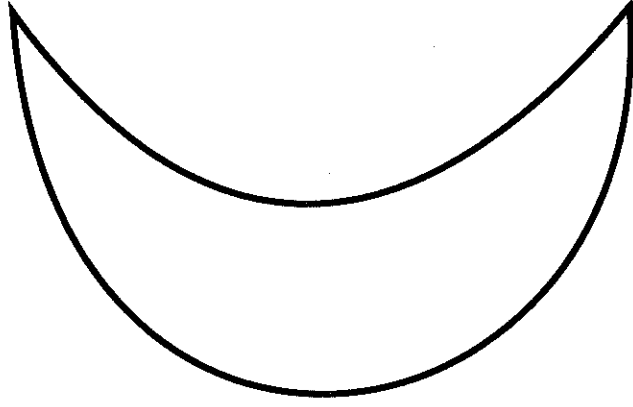

My book about

7

7 dwarves

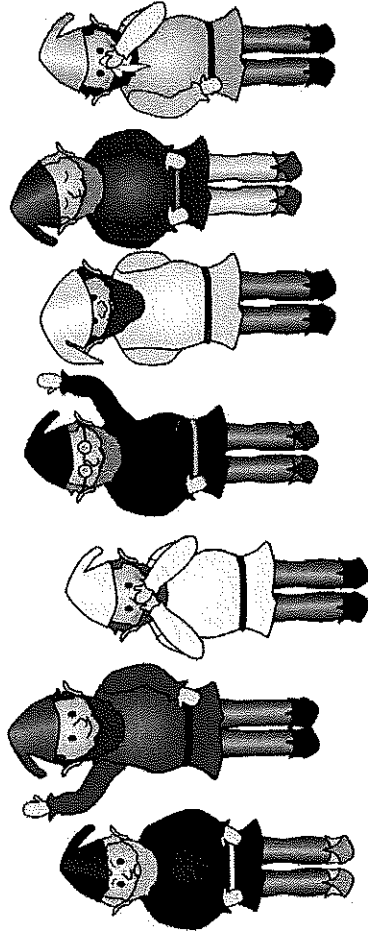

This book belongs to

\_\_\_\_\_

Can you see 7?

Find all the number 7s and circle them.

7

9

5

7

2

0

1

7

6

7

6

2

4

4

7

Draw 7 pencils in the pencil case.

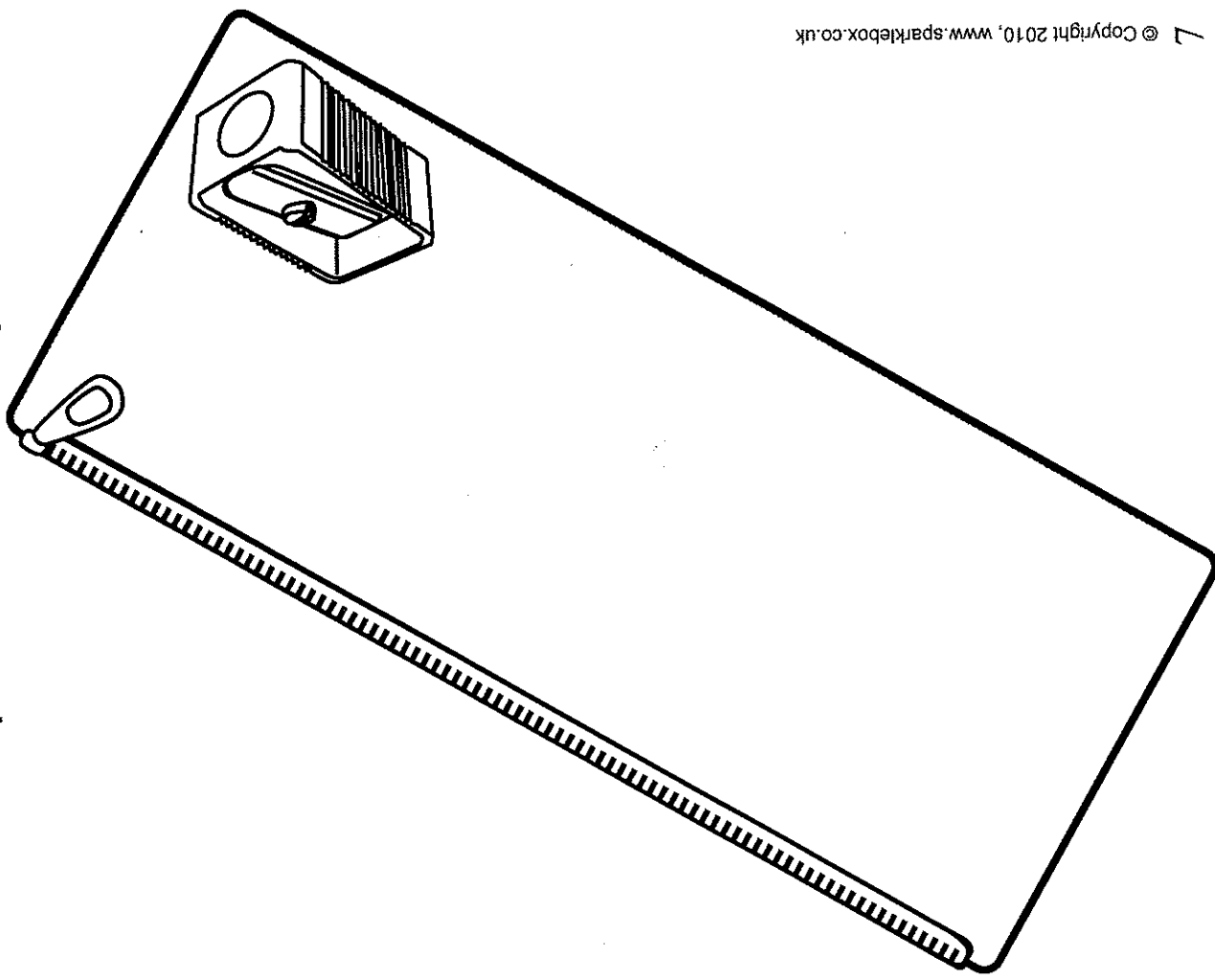

# Shout out 7!

Slowly trace your hand along the line. When you reach a number 7, shout it out!

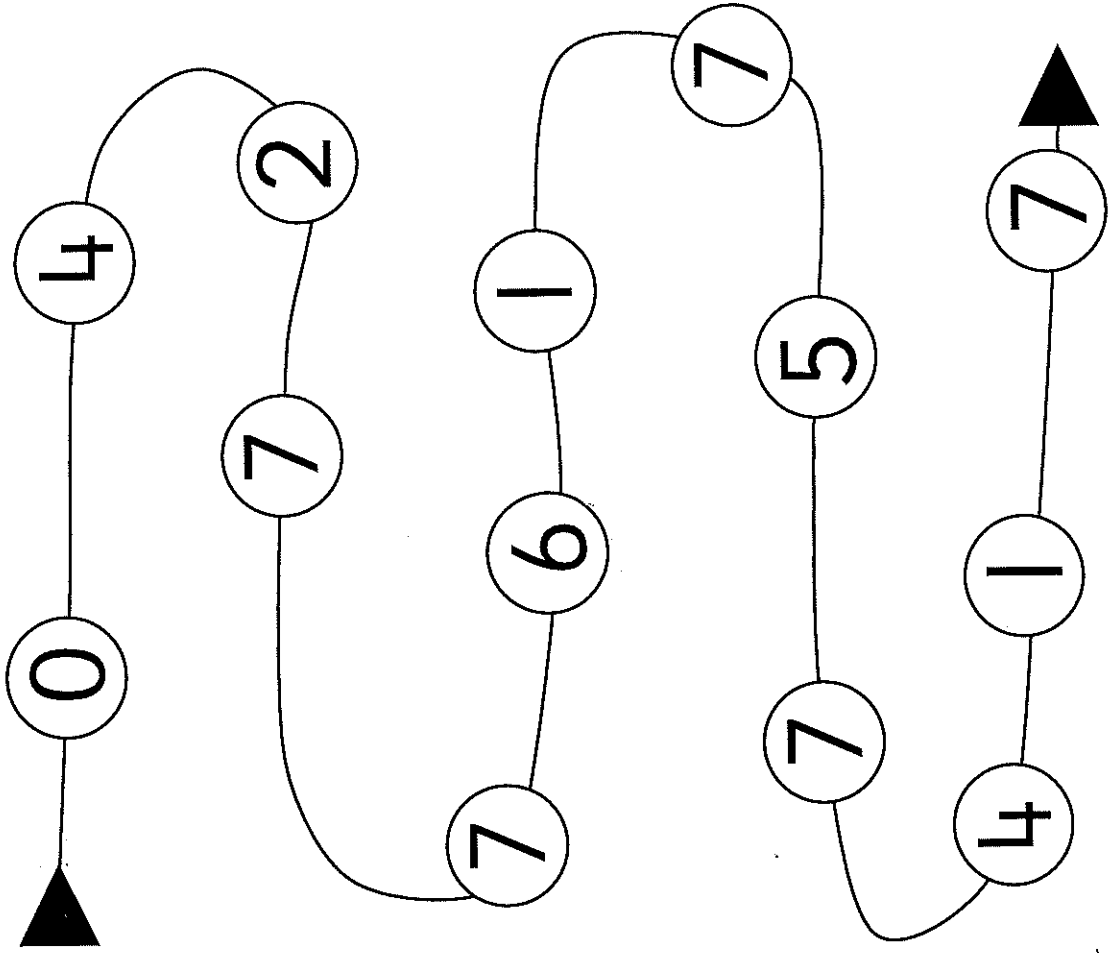

Choose 6 rainbow colours and trace within the giant 7 below.

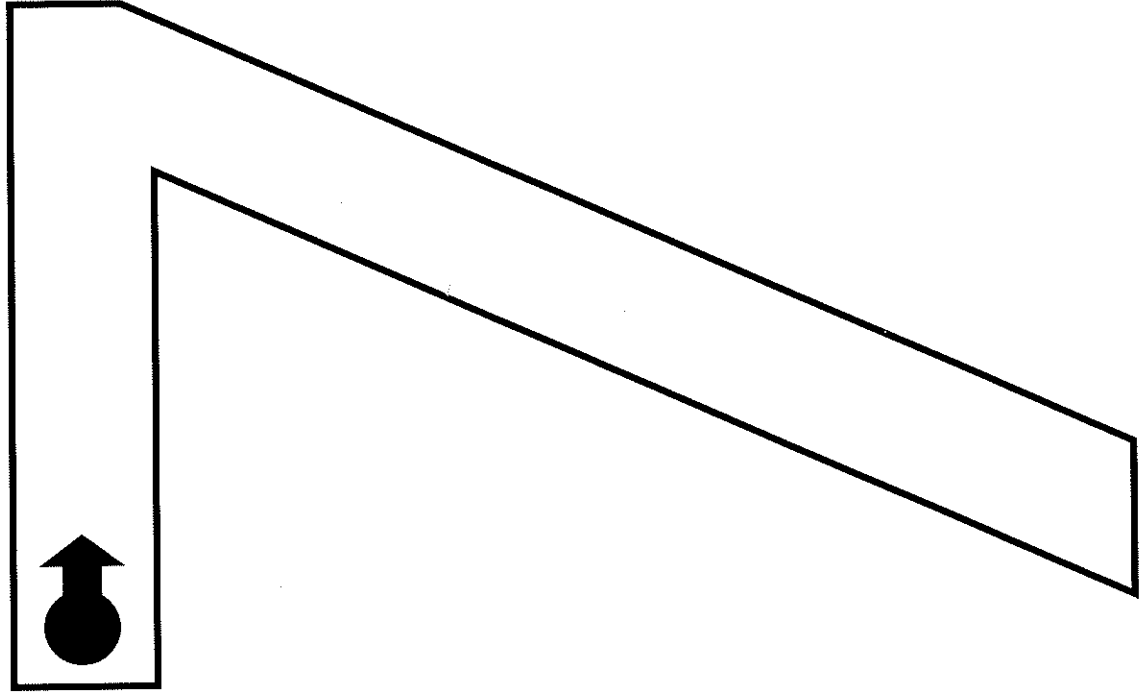

Write 7 in the circles next to the purses that have 7 coins.

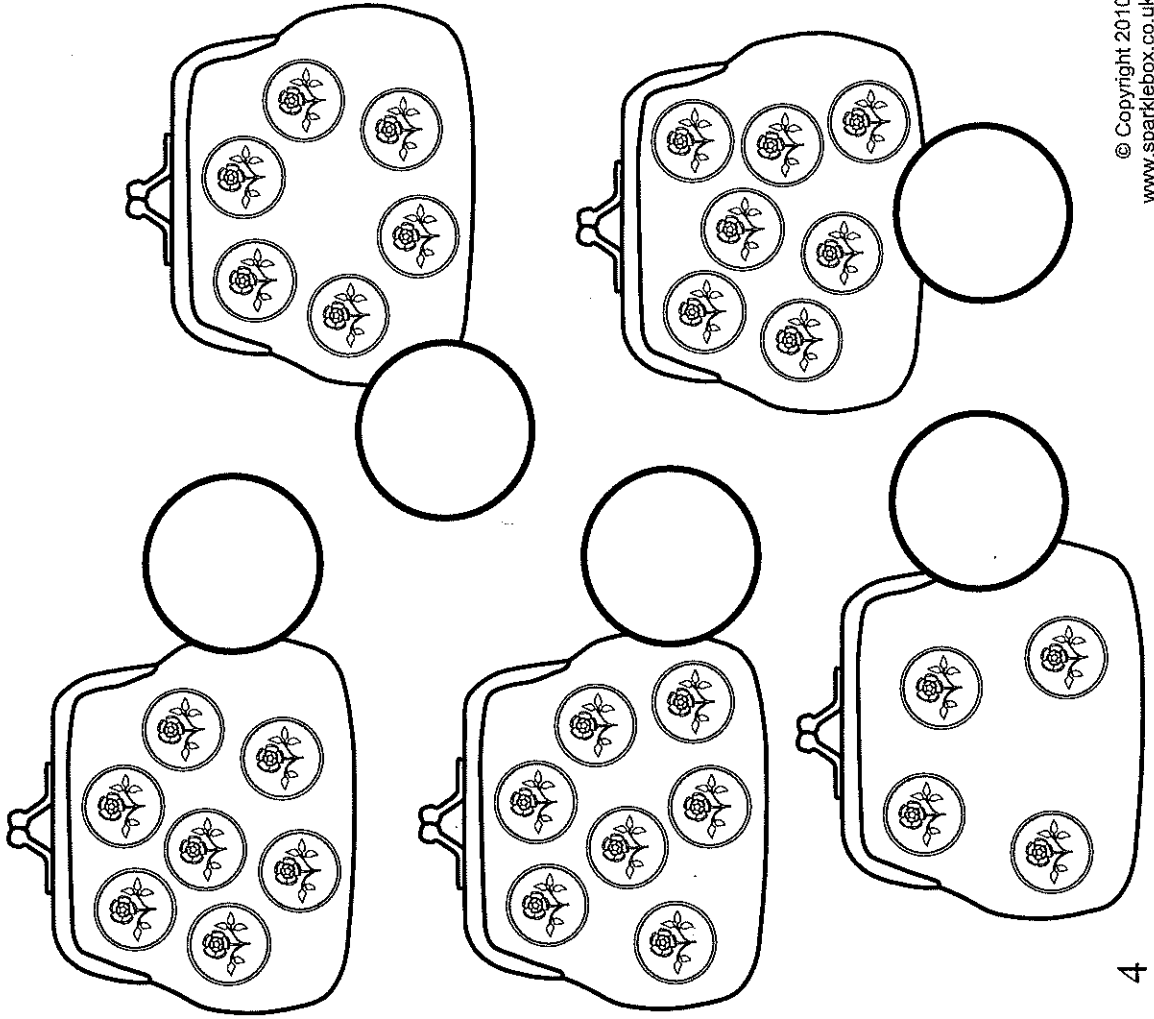

Draw 7 dwarves by Snow White.

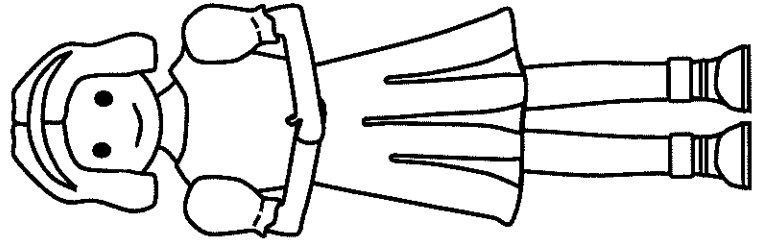



My book about

8

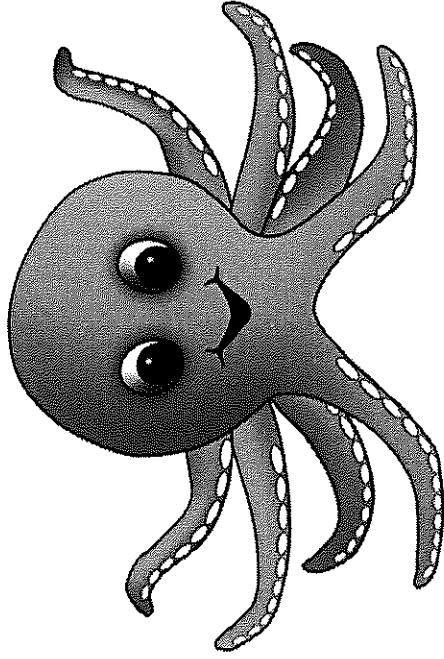

8 legs

This book belongs to

\_\_\_\_\_

Can you see 8?

Find all the number 8s and circle them.

9 8 5 3  
2 0 7 8  
3 6 8 8  
4 8 5

Draw 8 legs for the octopus.

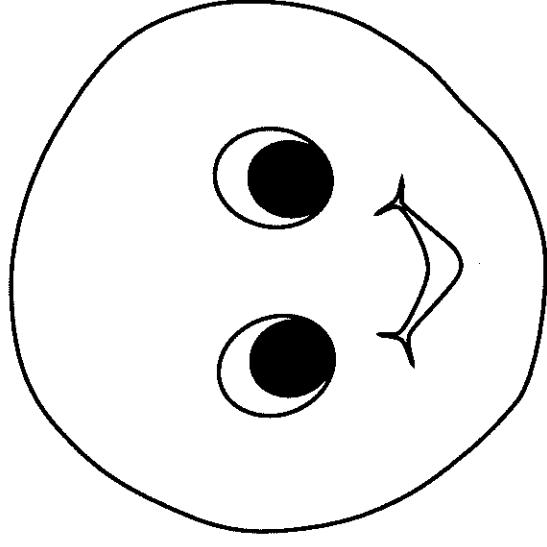

Shout out 8!

Slowly trace your hand along the line. When you reach a number 8, shout it out!

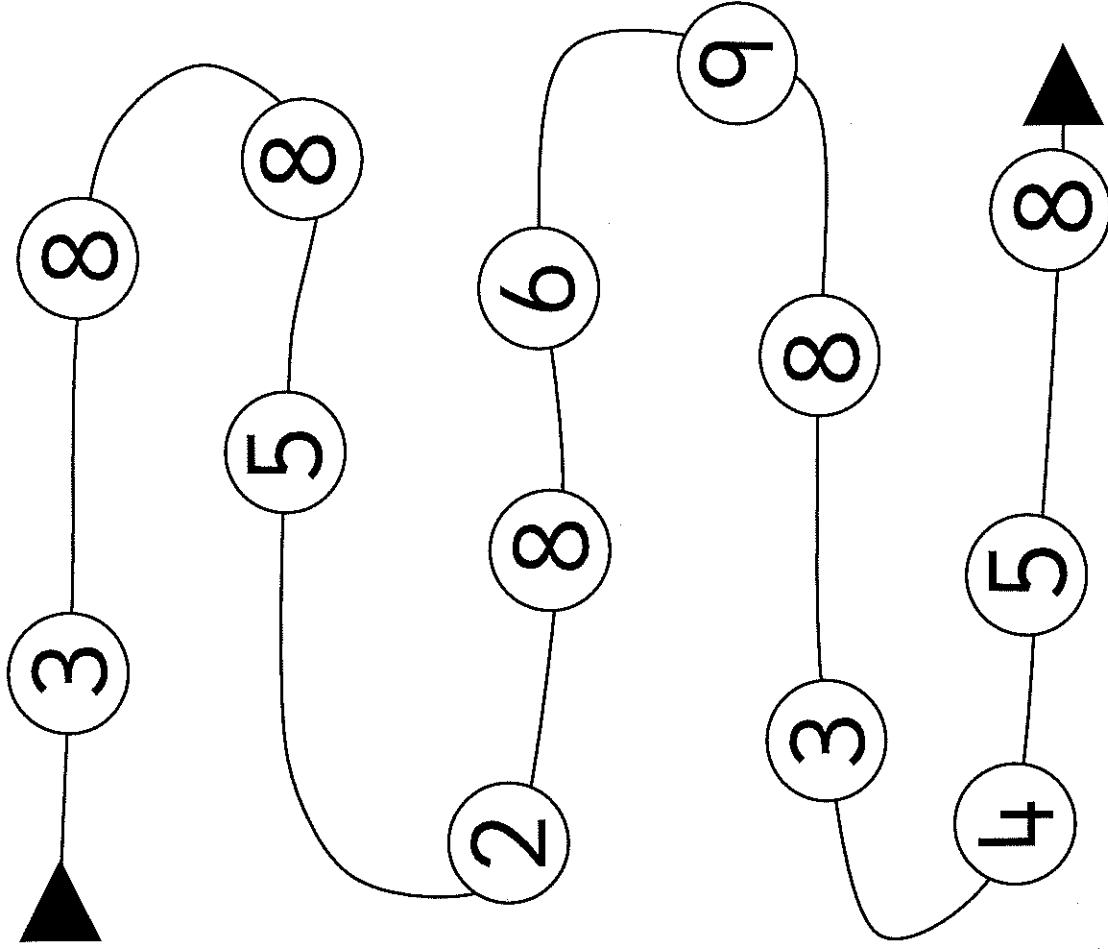

Choose 6 rainbow colours and trace within the giant 8 below.

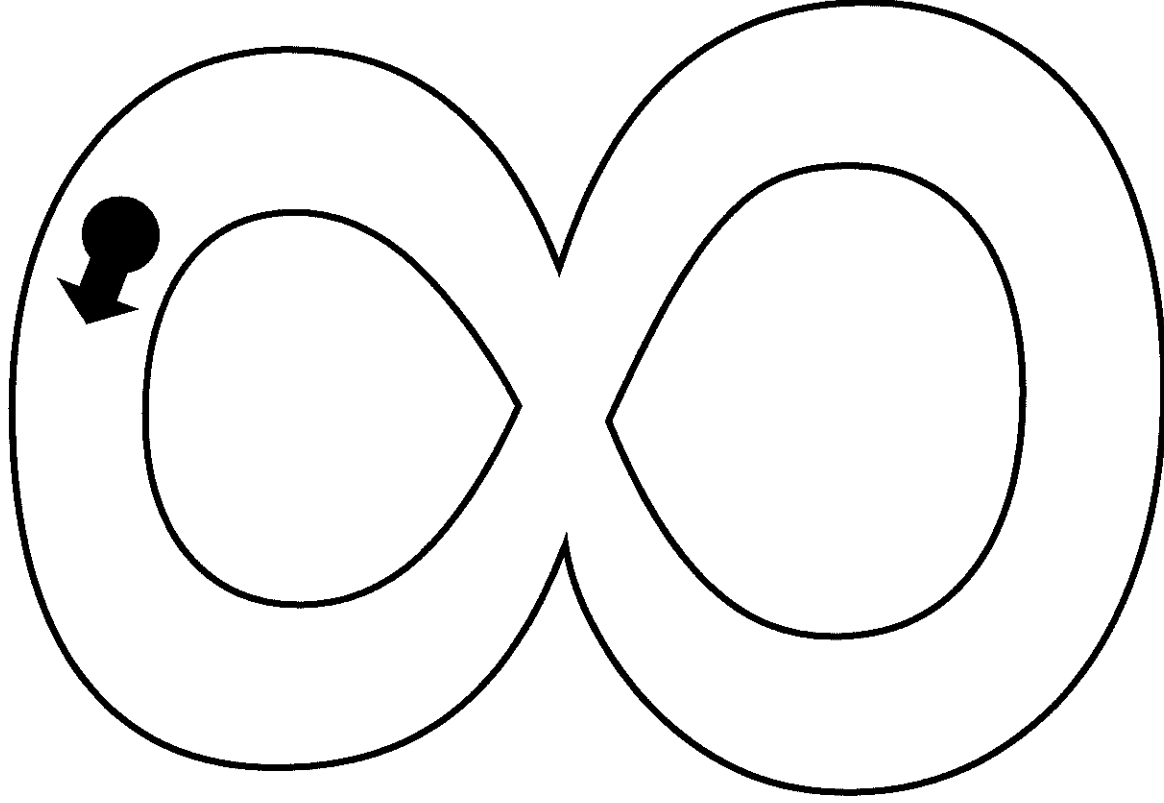

Write how many in the circles.

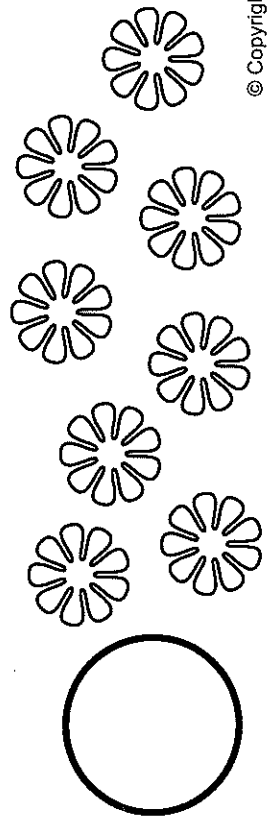
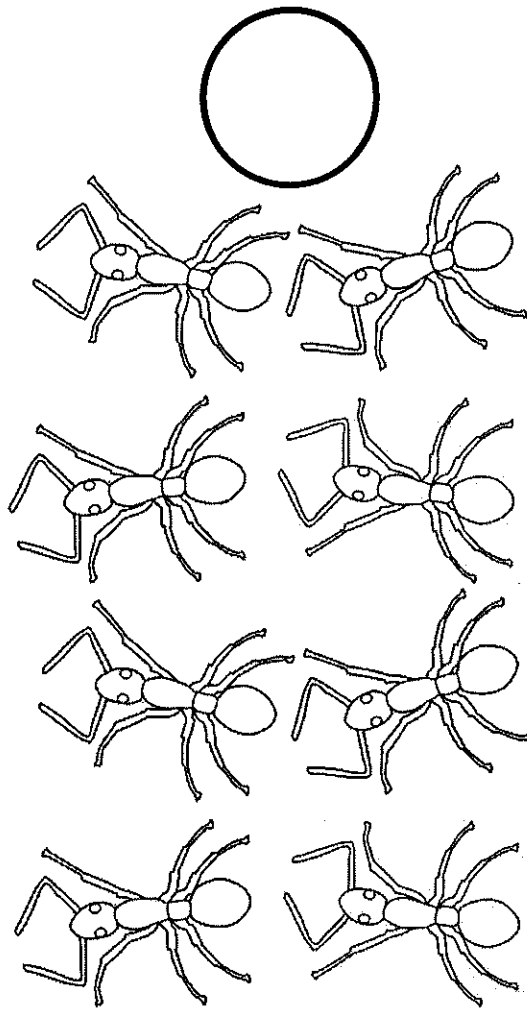
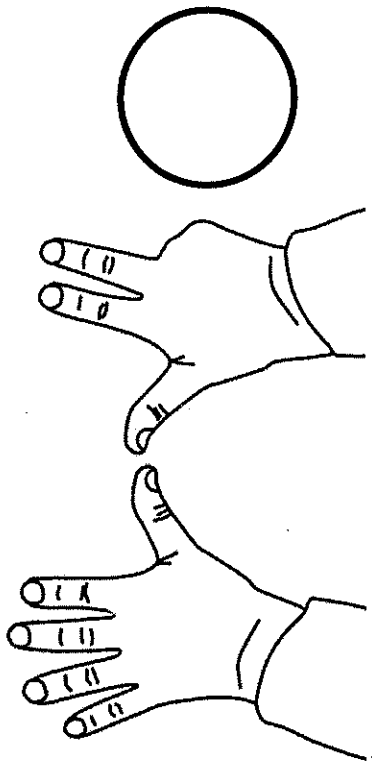

Draw 8 spiders with 8 legs on the web.

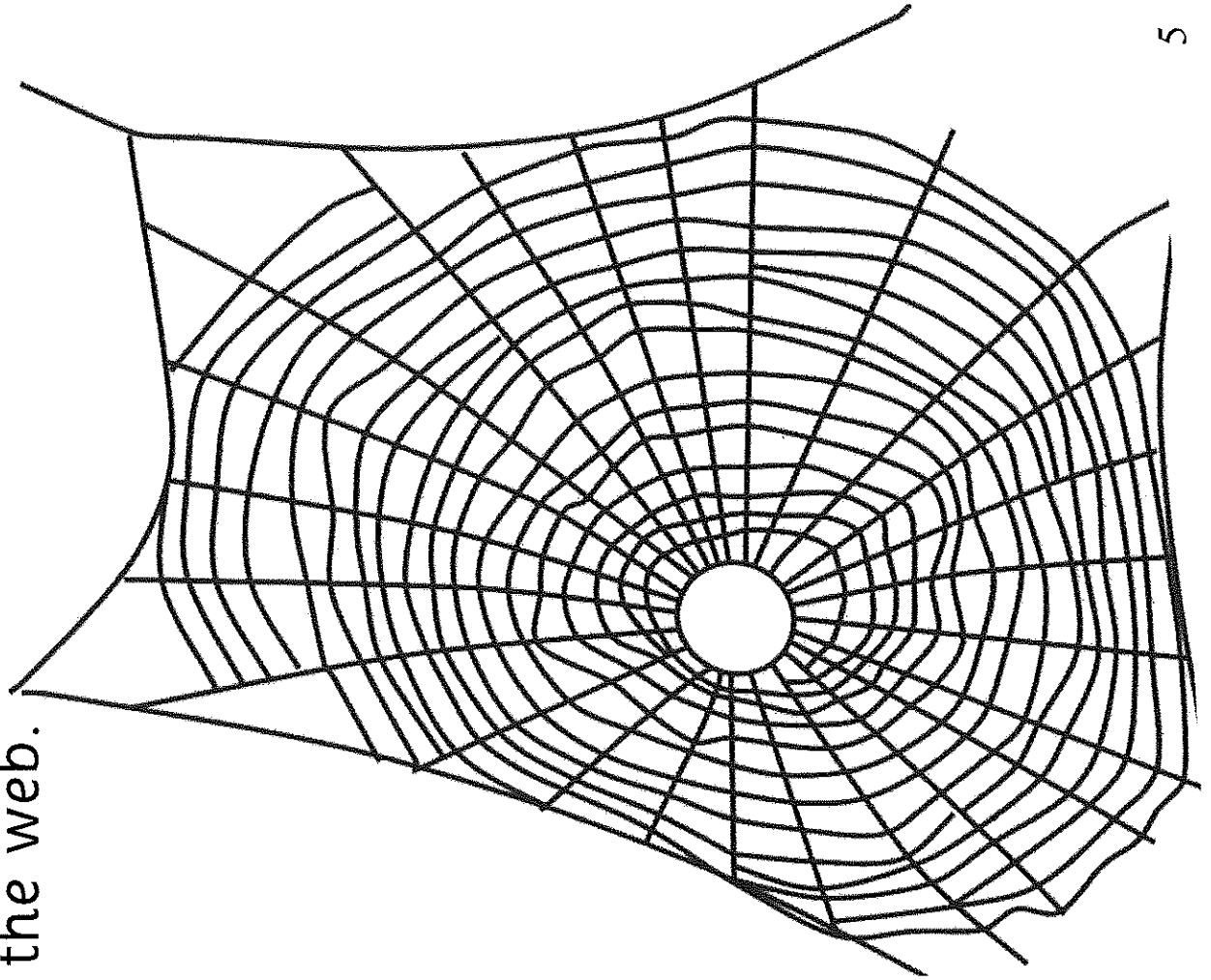

My book about

# 9

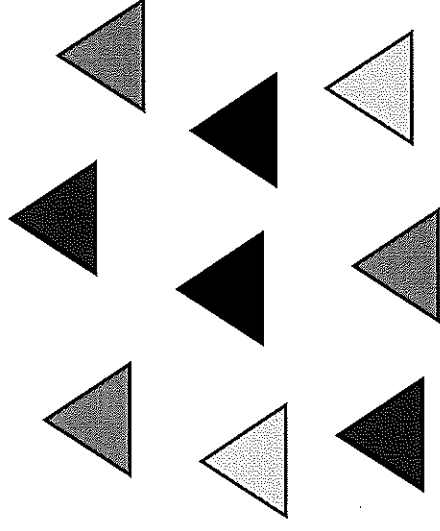

9 triangles

This book belongs to

\_\_\_\_\_

Can you see 9?

Find all the number 9s and circle them.

7 0 9 5  
9 8 9 6  
4 9 3  
6 4 8 9

Draw 9 spots on the sock.

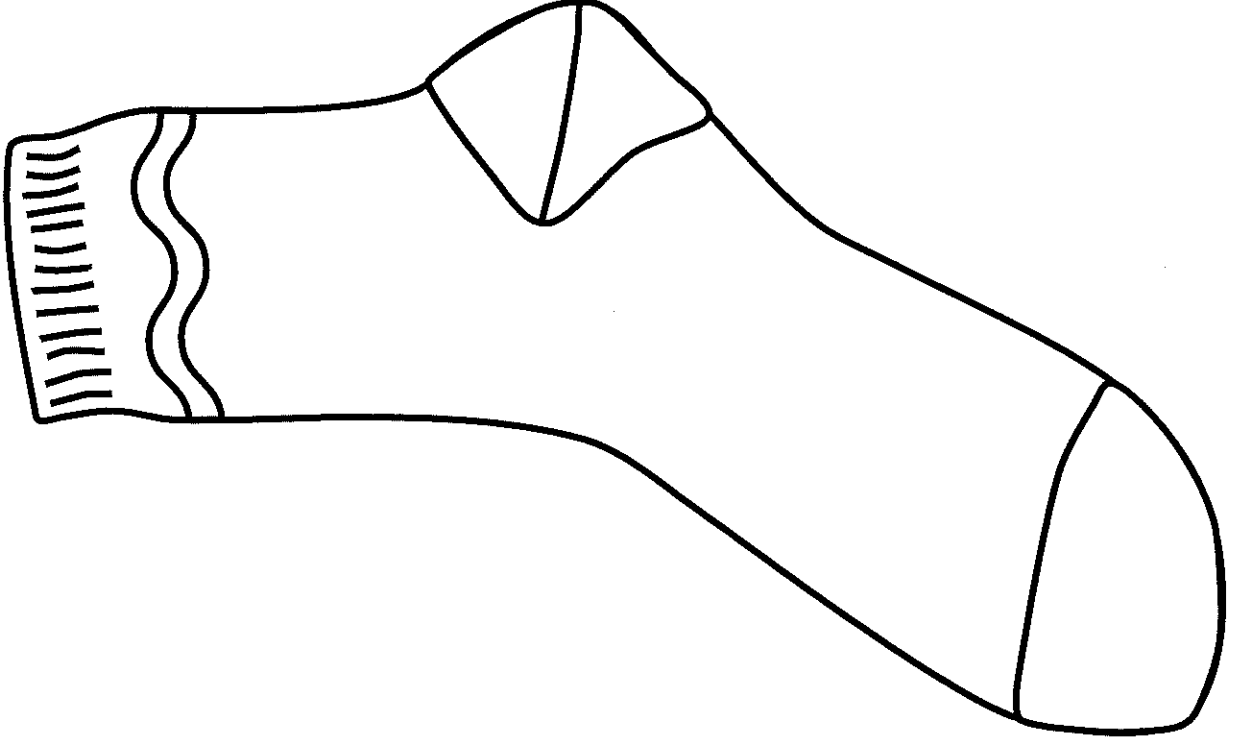

Shout out **9!**

Slowly trace your hand along the line. When you reach a number 9, shout it out!

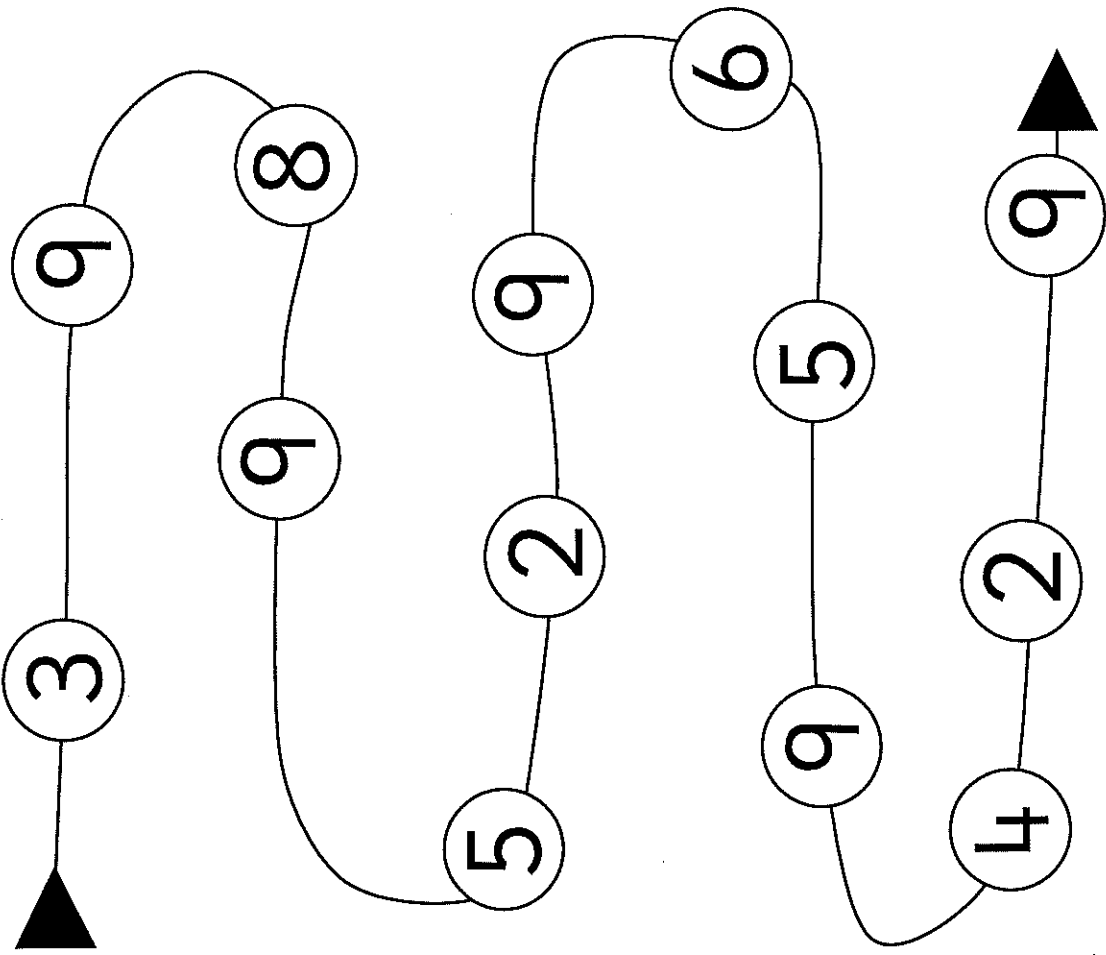

Choose 6 rainbow colours and trace within the giant 9 below.

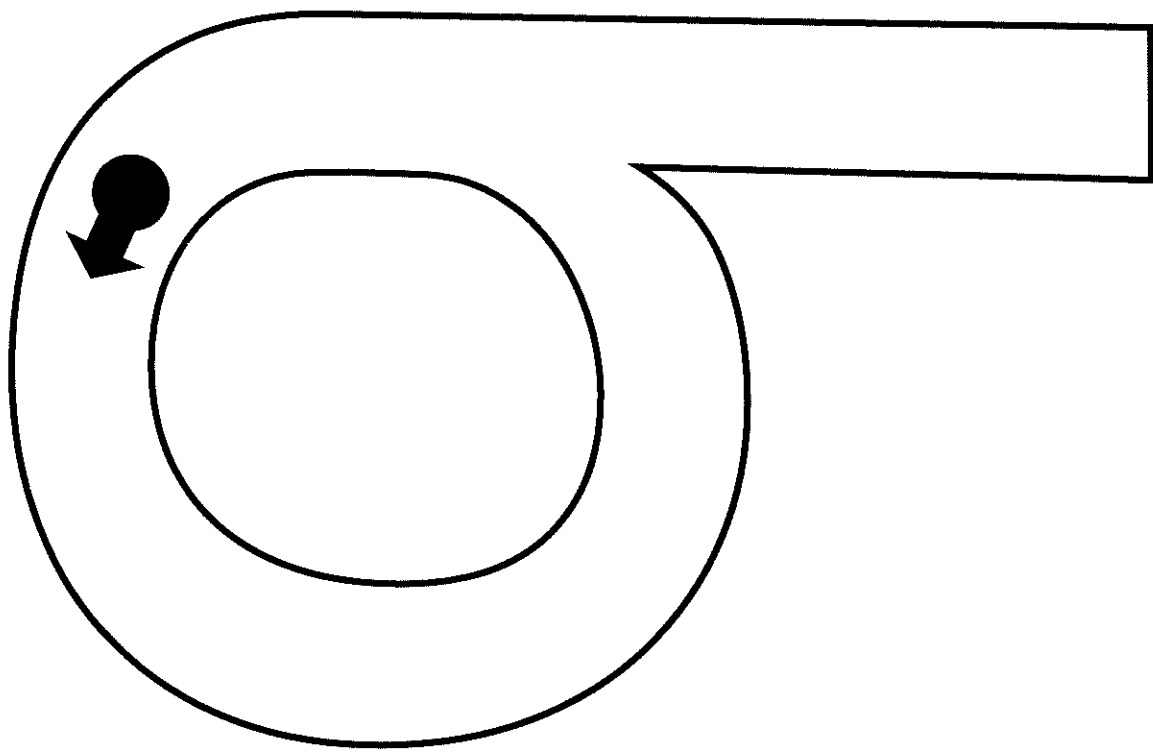

Colour the number 9 scissors.

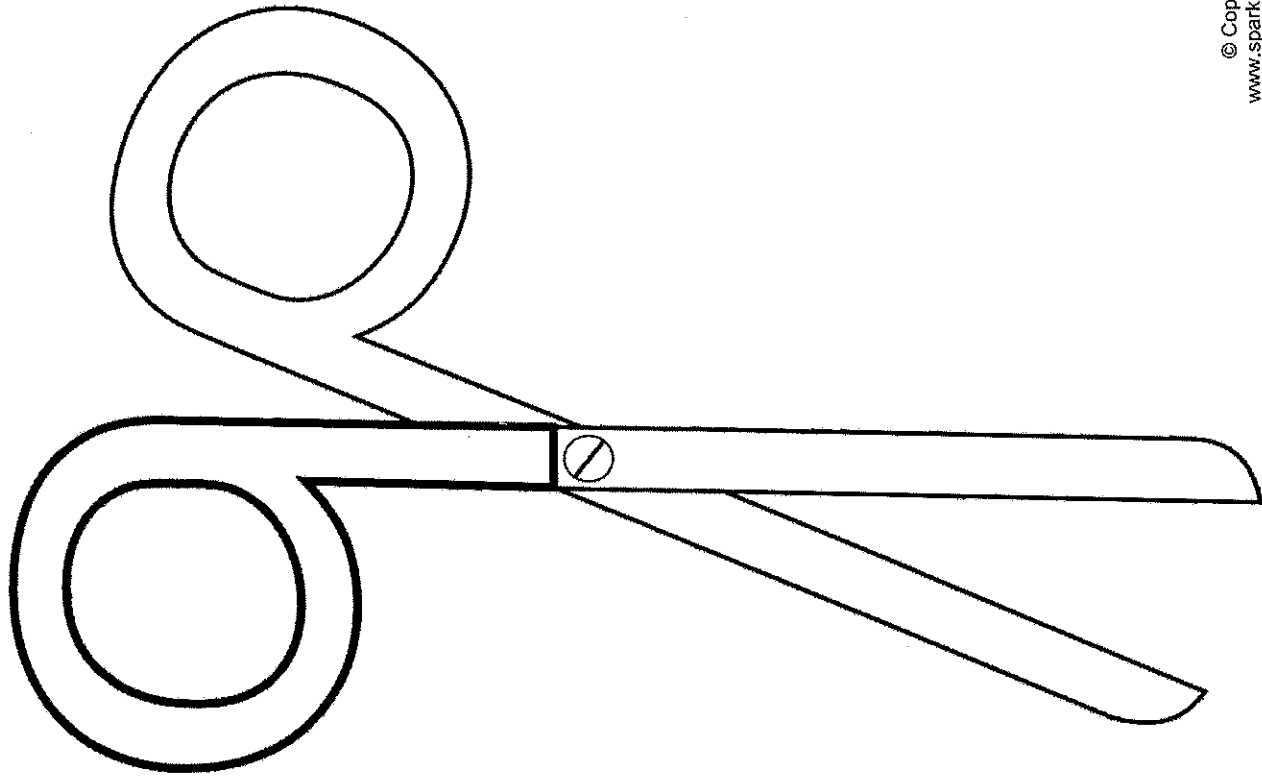

Draw 9 balls for the juggler to juggle.

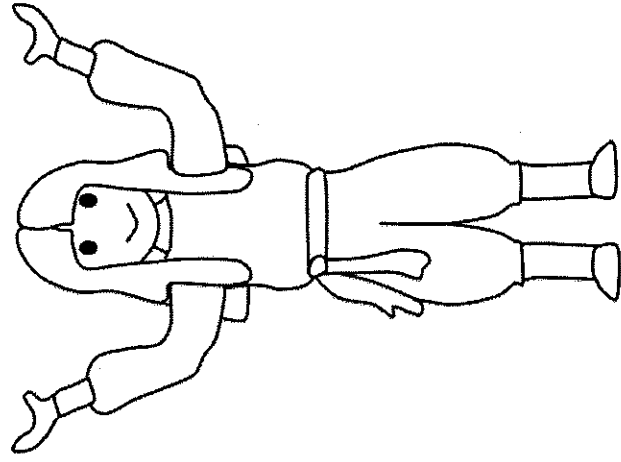



My book about

9

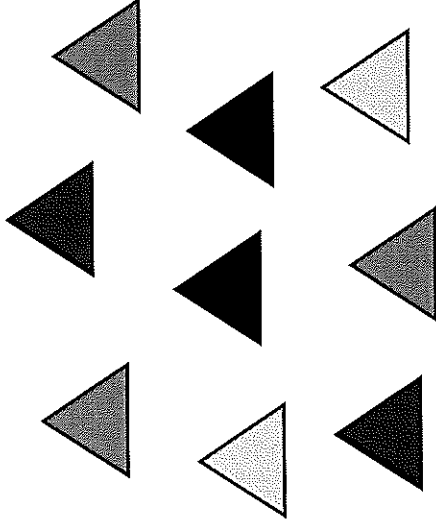

9 triangles

This book belongs to

\_\_\_\_\_

Can you see 9?

Find all the number 9s and circle them.

7 0 9 5  
9 8 9 6  
4 9 3  
6 4 8 9

Draw 9 spots on the sock.

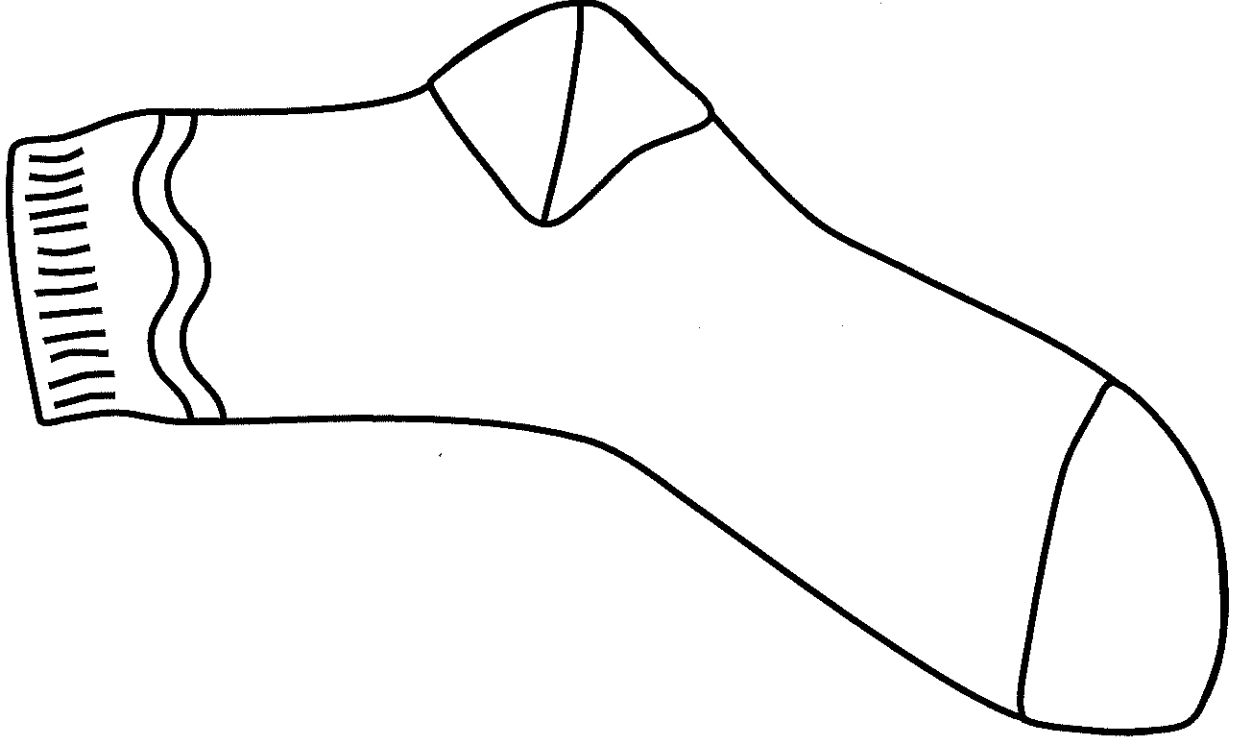

Shout out **9!**

Slowly trace your hand along the line. When you reach a number 9, shout it out!

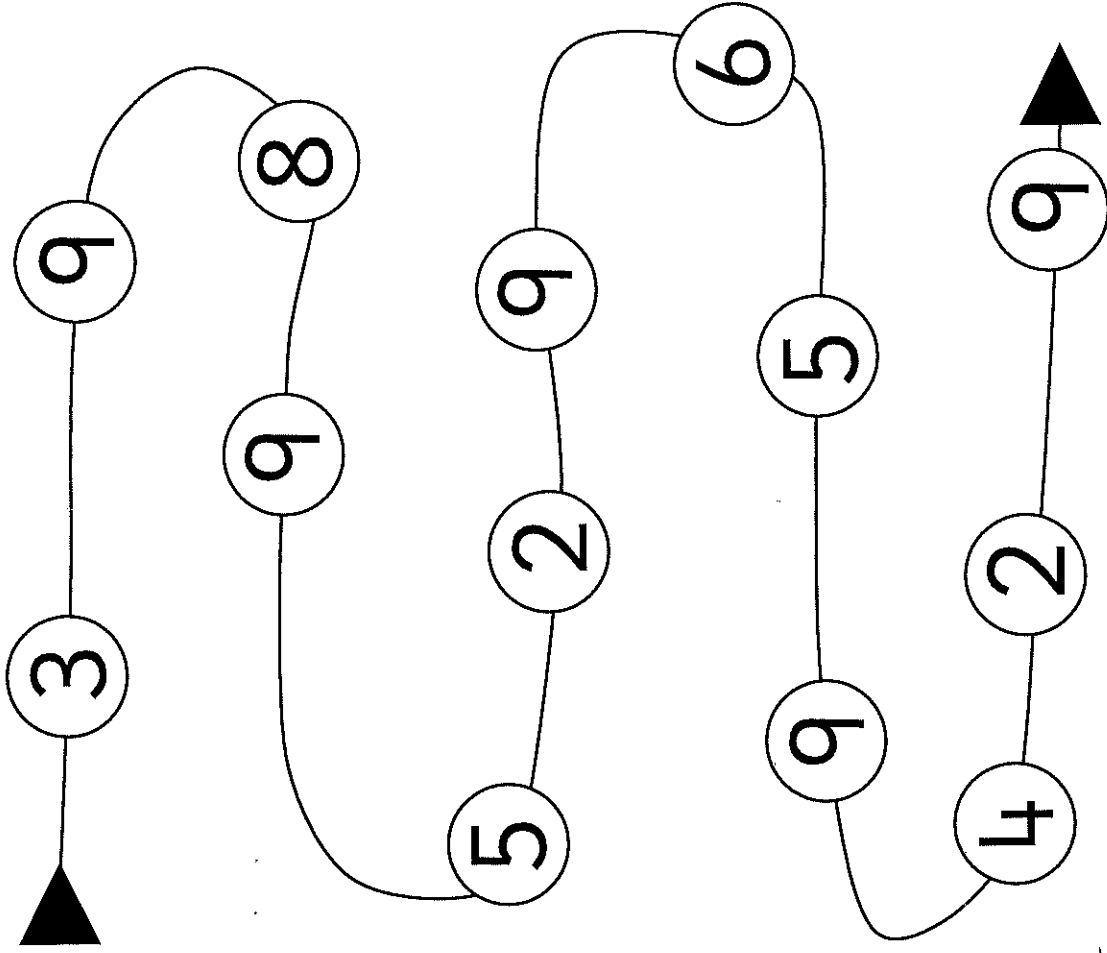

Choose 6 rainbow colours and trace within the giant 9 below.

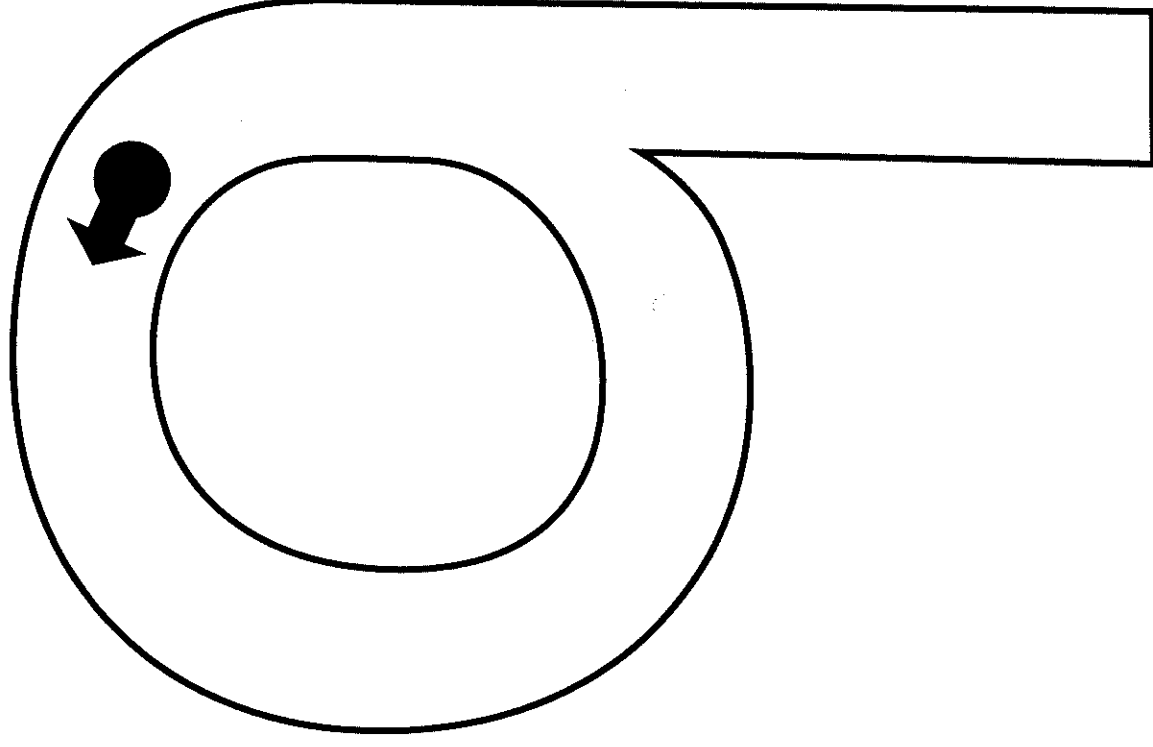

Colour the number 9 scissors.

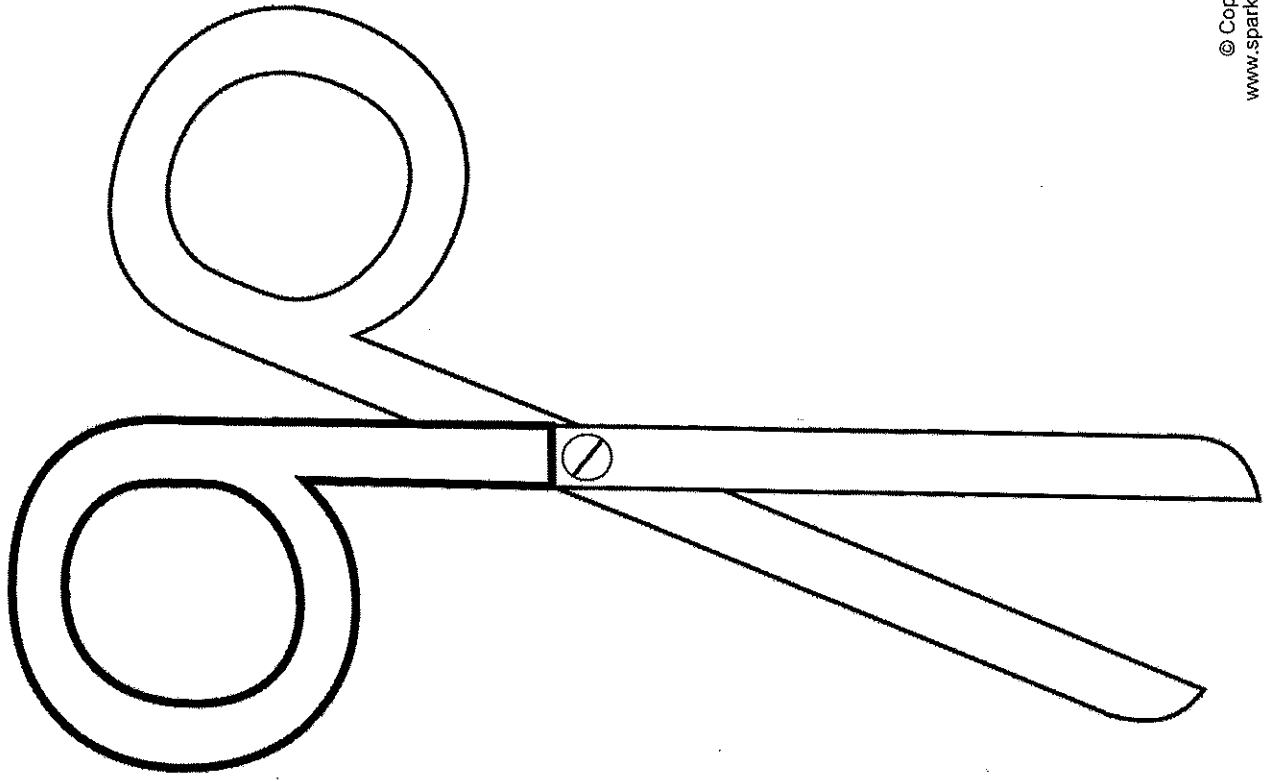

Draw 9 balls for the juggler to juggle.

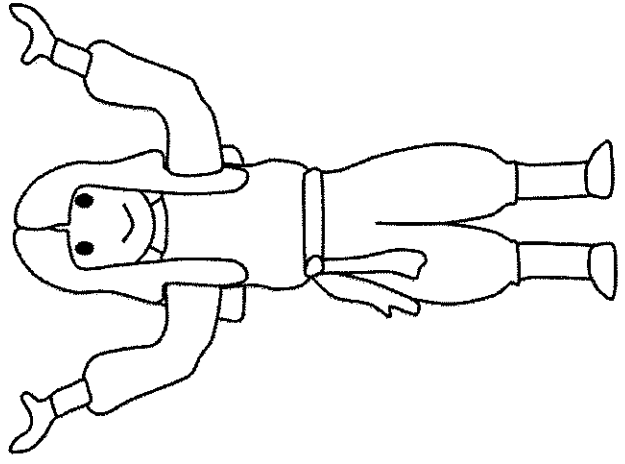

My book about

# 10

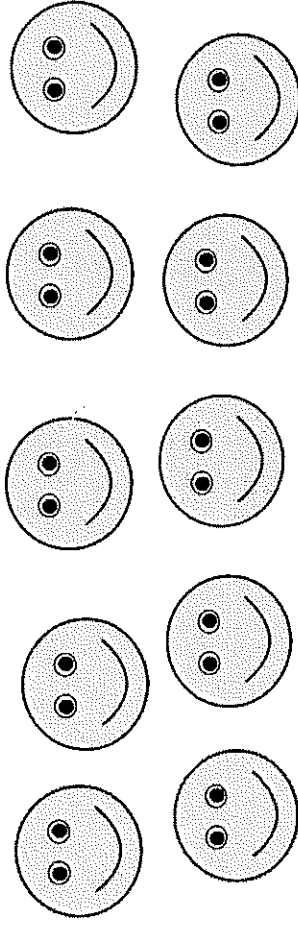

10 smiley faces

This book belongs to

---

Can you see 10?

Find all the number 10s and circle them.

1 9 10 18 10 10 10 10 10 10 10 14 0 16 15 13 10

Colour 10 of the building bricks.

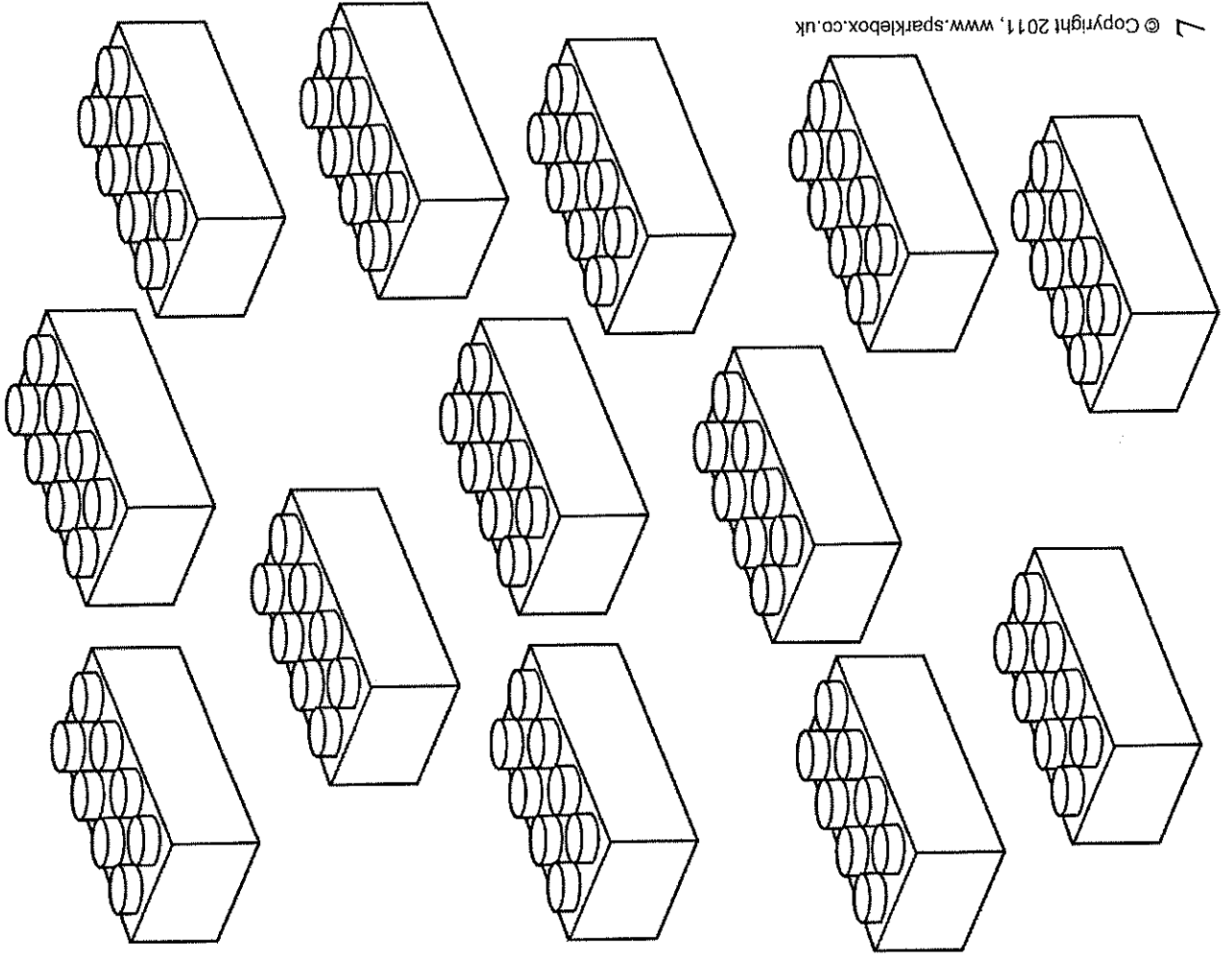

# Shout out 10!

Slowly trace your hand along the line. When you reach a number 10, shout it out!

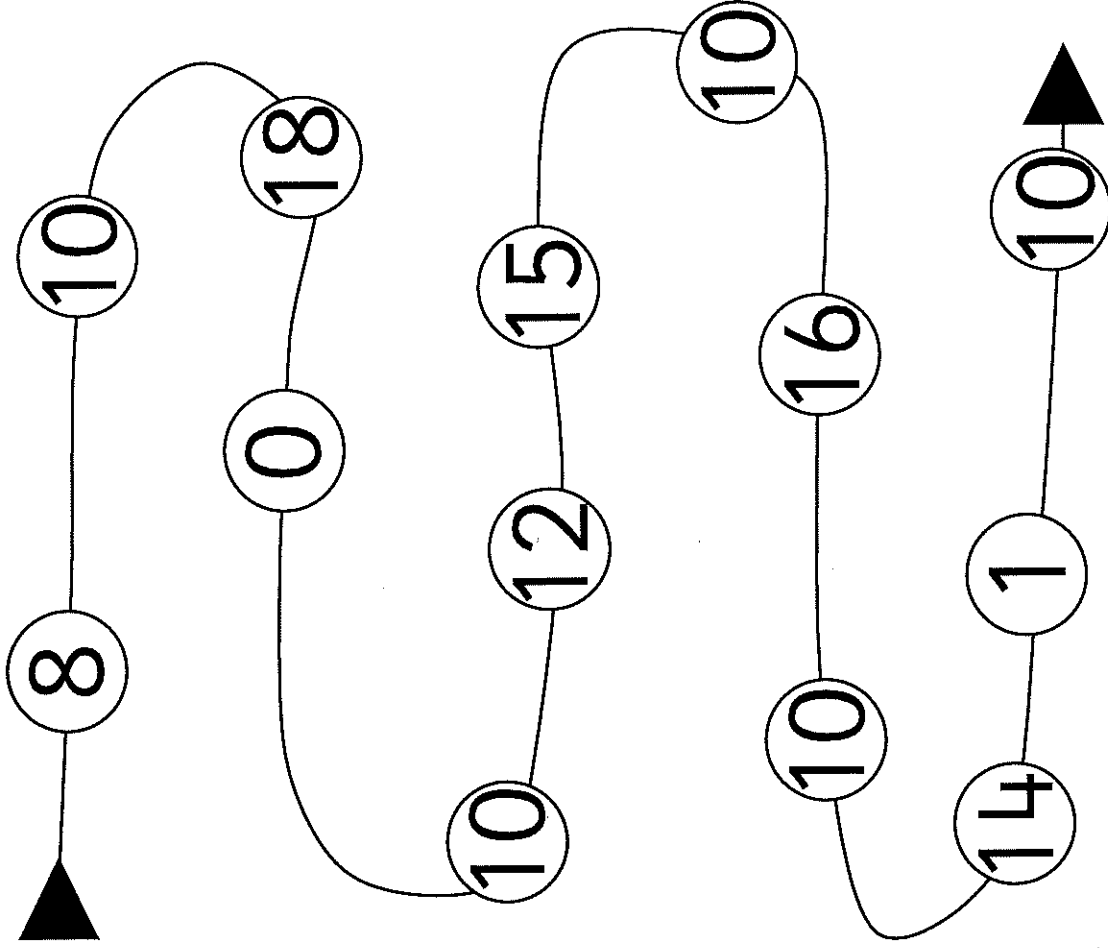

Choose 6 rainbow colours and trace within the giant 10 below.

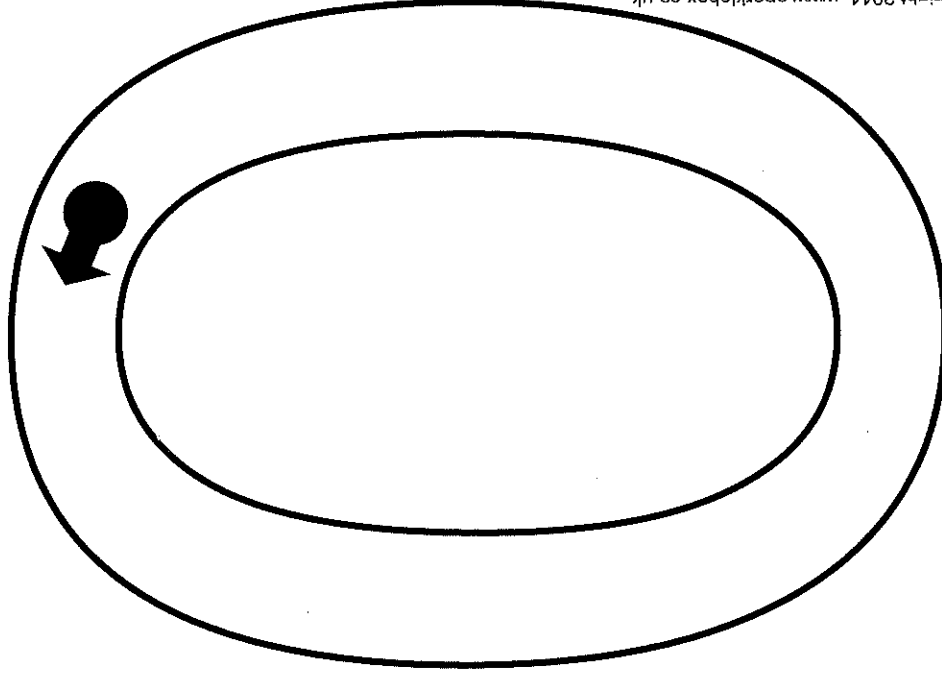

Colour the number 10 men.

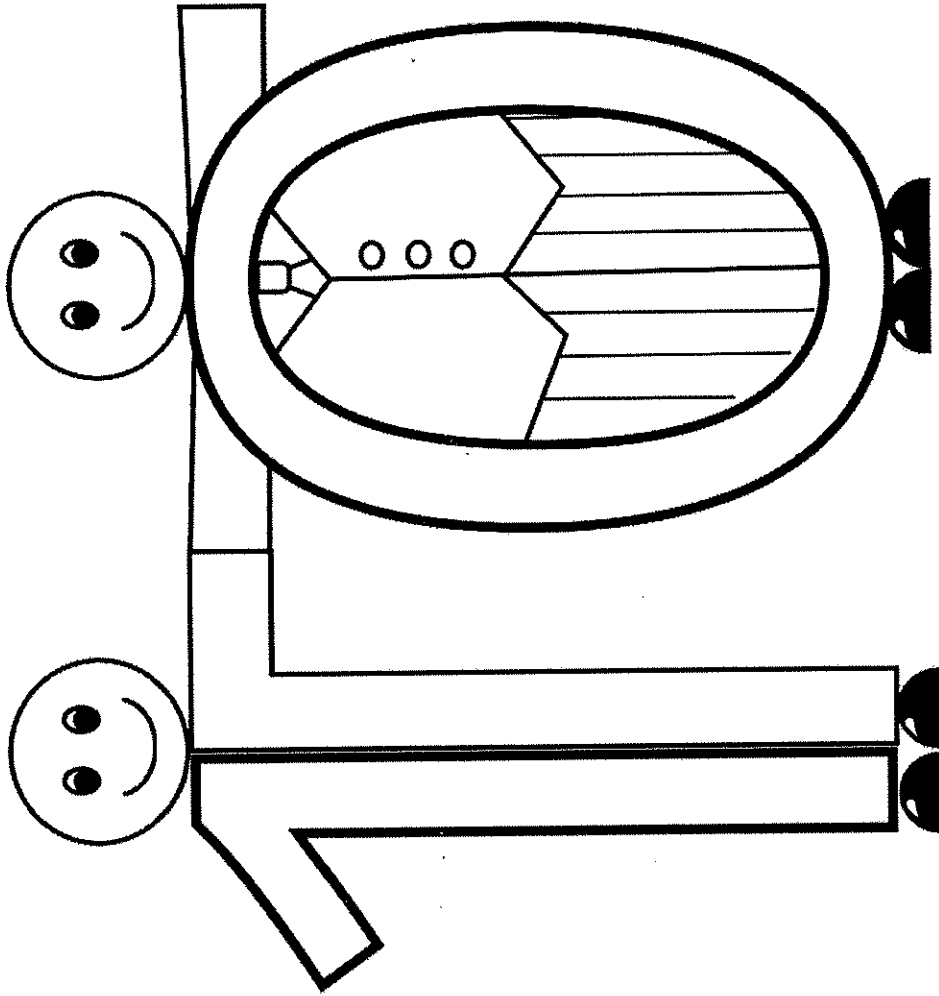

Draw 10 raindrops falling on the umbrella.

